

小学校一年生 漢字の筆順練習【口】

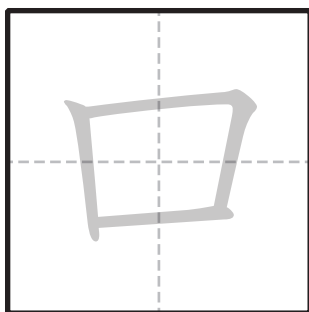
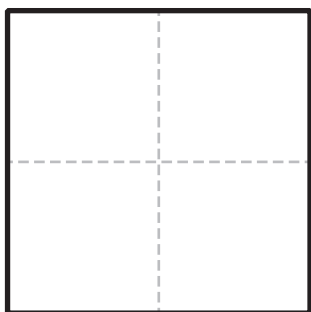
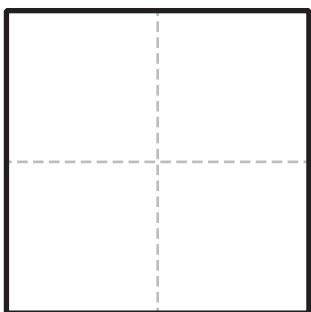
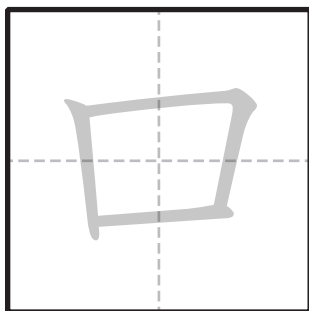
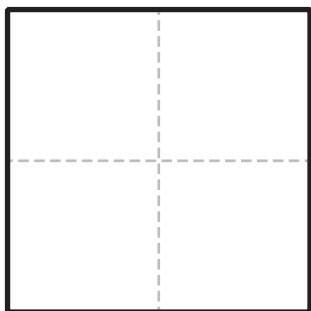
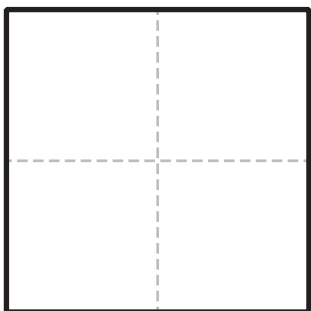
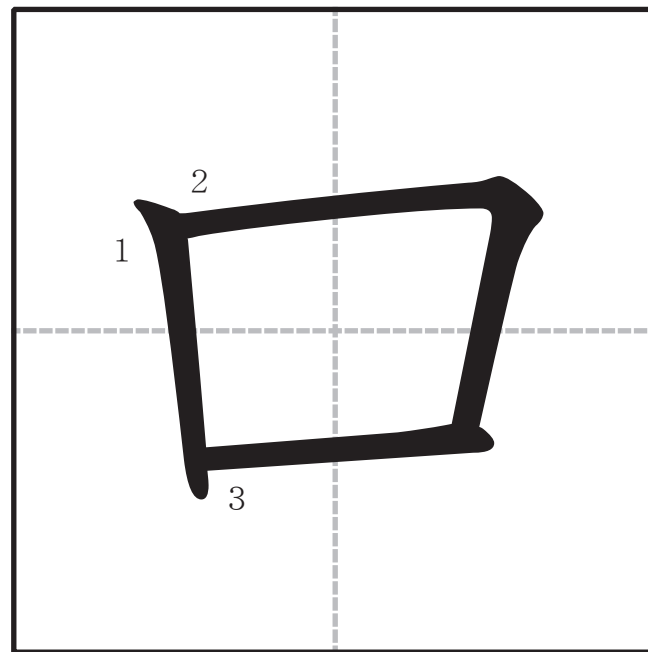
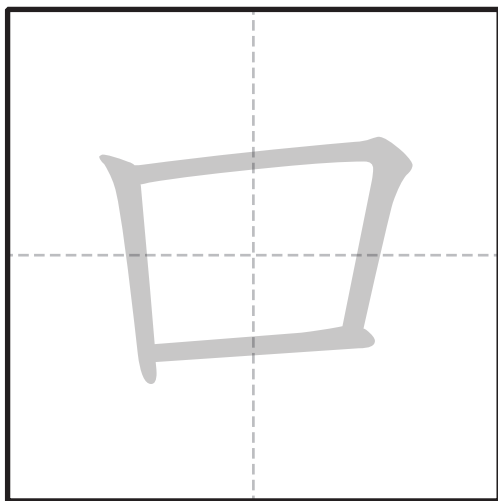
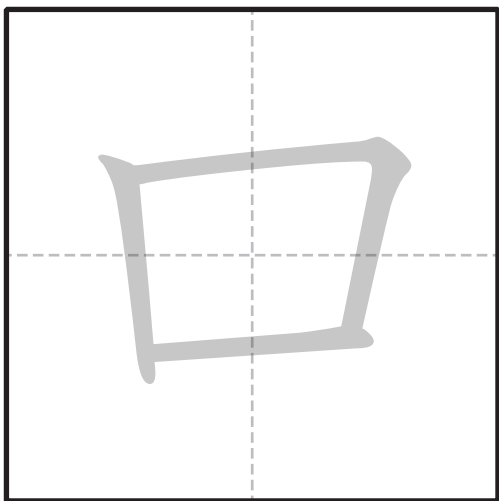

【音読み】
コウ・ク
【訓読み】
くい